

Quick Installation Guide

— Triple Power Lithium-ion Battery

III

Install BMS on Battery Module

Install the BMS on the battery module. Fix it with M5 screws on holes shown as below with L-type Wrench. Please pay attention to the correct direction of BMS and battery modules, and put the same side of BMS and battery modules at front.

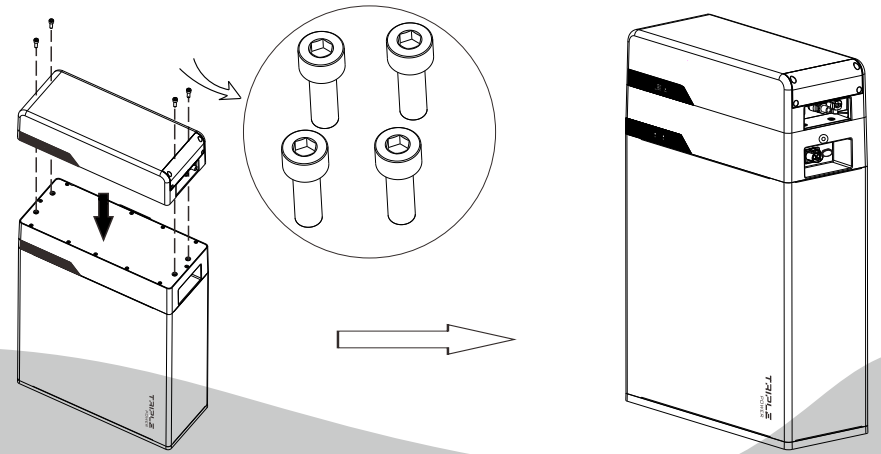

I

Packing List

Note: The quick installation guide describes installation steps briefly. If you have any questions during the installation, please refer to the User Manual for more information.

BMS				
Battery Module				

IV

Floor/Wall Mounting (alternative)

Note: 1. For 2~4 battery modules, please finish the floor mounting or wall mounting before connecting cables!
2. Please make sure that the inverter is completely switched off when connecting cables!

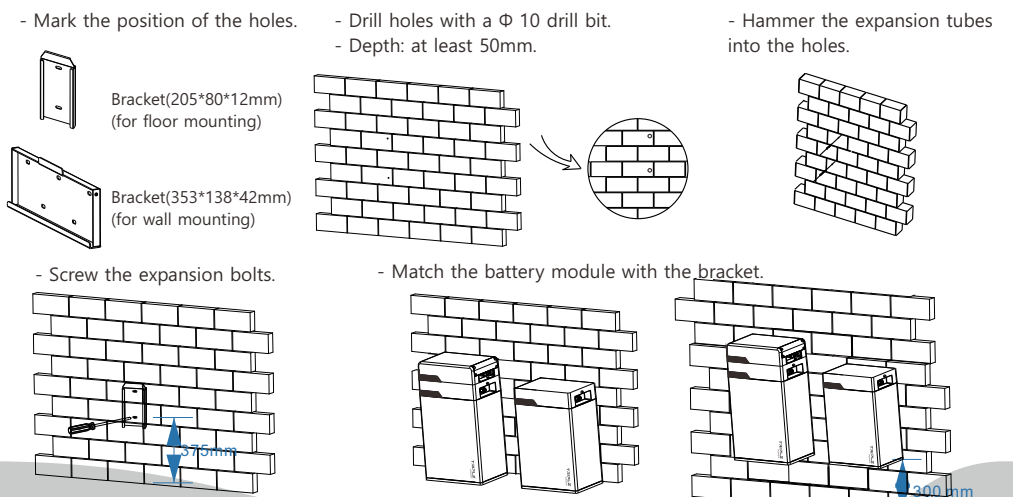

Note: for floor mounting, the distance between the bottom of battery module and the lower hole of wall bracket is 375mm; It is recommended to keep a distance of at least 250mm between battery modules; for wall mounting, the distance between the bottom of battery module and floor shall not exceed 300mm.

II

Installation Prerequisites

Make sure that the installation location meets the following conditions:

- The building is designed to withstand earthquakes
- The location is far away from the sea, to avoid saline water and humid air
- The floor is flat and level
- There are no flammable or explosive materials nearby
- The ambient environment is shady and cool, and away from heat as well as direct sunlight
- The temperature and humidity stay at a constant level.
- There is minimal dust and dirt in the area.
- There is no corrosive gases present, including ammonia and acid vapor.
- The ambient temperature is within the range from 0°C to 45°C, and the optimal ambient temperature is between 15°C and 30°C.

NOTE!

The Triple Power battery is rated at IP55 and thus can be installed outdoors as well as indoors. However, if installed outdoors, do not expose the battery directly to sunlight and moisture.

NOTE!

If the ambient temperature is beyond the operating range, the battery will stop operating to protect itself. The optimal temperature range for the battery to operate is from 15°C to 30°C. Frequent exposure to harsh temperatures may deteriorate the performance and lifetime of the battery.

V

Power Cable Connection

- For one battery module :

- Step 1.** Plug either end of the 120mm power cable into the XPLUG port on BMS, and the other end into the XPLUG port on battery module.
- Step 2.** When the metal sheet is totally inserted and a click sound is heard, that means the power cable is properly connected.
- Step 3.** Once finished, please connect the short-circuit plug to the YPLUG port on battery module to complete the internal circuit.

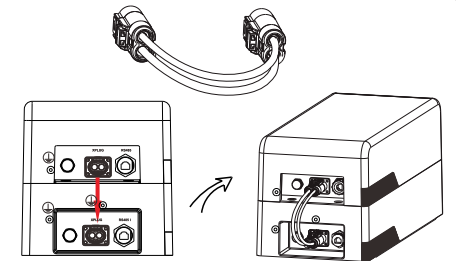

- For more battery modules:

- Step.1** Plug either end of the 120mm power cable into the XPLUG port on BMS, and the other end into the XPLUG port on the first battery module.
- Step.2** Then plug one end of the 400mm power cable into the YPLUG port on the first battery module, and the other end into the XPLUG port on the next battery module.
- Step.3** Repeat the same step on all the battery modules.
- Step.4** Once finished, please connect the short-circuit plug to the YPLUG port on the last battery module to complete the internal circuit.

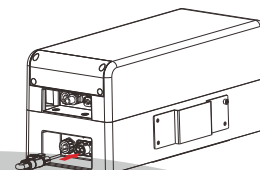

VI

RS485 Connection

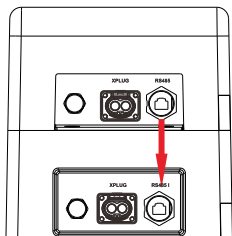

Step1. Connect the RS485 communication cable (120mm) from the RS485 port on BMS to the RS485 I port on the first battery module.

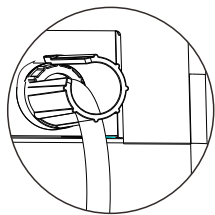

Step2. Tighten the plastic screw caps on both ends of the cable with the rotation wrench from the package.

Note: For 2-4 modules, please connect RS485 II port of the first battery module to RS485 I port on the next battery module. Repeat the same step to connect the rest battery modules.

The wiring order of the communication cable is as follow:

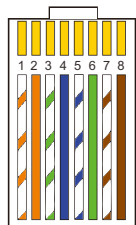
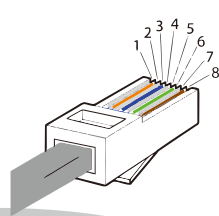

- 1) White with an orange stripe
- 2) Orange
- 3) White with a green stripe
- 4) Blue
- 5) White with a blue stripe
- 6) Green
- 7) White with a brown stripe
- 8) Brown

Sequence	1	2	3	4	5	6	7	8
RS485I	VCC_485	GND_485	B2	N-	P+	A2	VCC_485_2	GND_485
RS485II	VCC_485	GND_485	B2	N-	P+	A2	VCC_485_2	GND_485

IX

Battery Power Cable Connection 1

- One end of the battery power cable needs to be connected manually as below:

Step1.

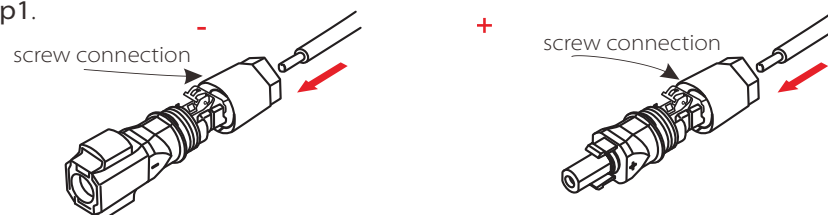

Step2.

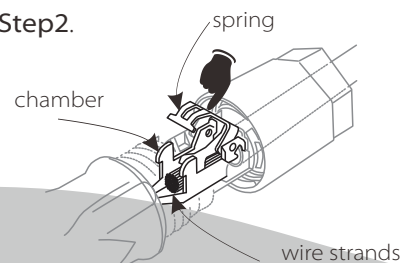

Step3.

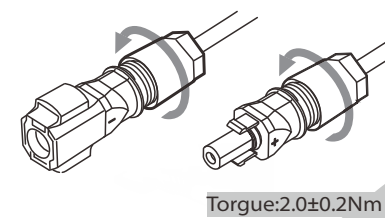

VII

CAN Connection

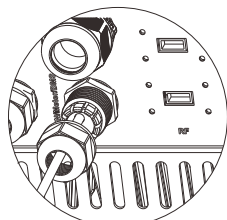

Step1: Make sure the inverter is turned off, and then insert one end of the CAN communication cable to the BMS port on the Inverter. Assemble the cable gland and screw the cable cap.

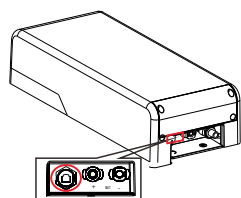

Step2: Connect the other end of CAN communication cable to the CAN port on BMS module which is marked in red. Tighten the cable cap on the cable with rotation wrench.

The wiring order of the communication cable is the same as RS485 communication cable

Sequence	1	2	3	4	5	6	7	8
CAN	/	GND	/	CAN_H	CAN_L	/	A1	B1

X

Battery Power Cable Connection 2

- Insert the battery power cable into the BAT connectors on the inverter as shown below:

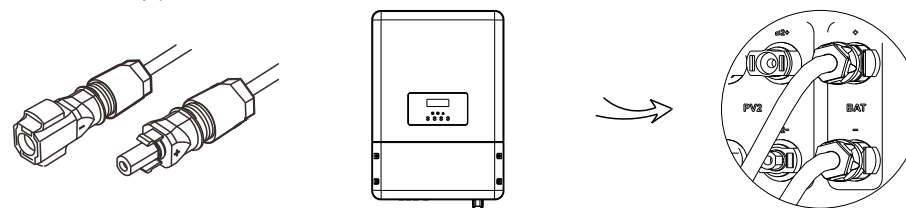

- Insert the other end of the battery power cable into the BAT connectors on the BMS:

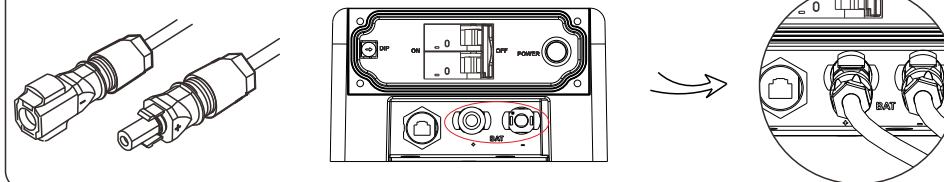

- To dismantle the charging cable, please operate it with slotted screwdriver as shown in the figure. Please DO NOT unplug them directly with brute force!

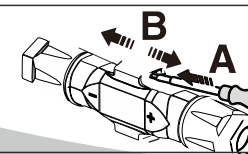

VIII

Ground Connection

For one battery module:

Unscrew the ground terminal with hexagon wrench on BMS and battery module at the two ground screws circled in red below. Connect the ground wire from BMS to battery module.

Cable size: 10AWG.

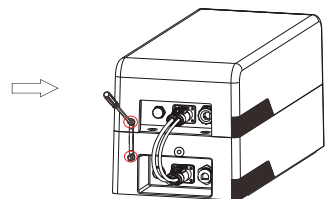
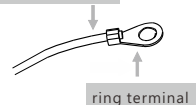

For 2~4 battery modules:

The terminal points for GND connection between battery modules are circled in red below.

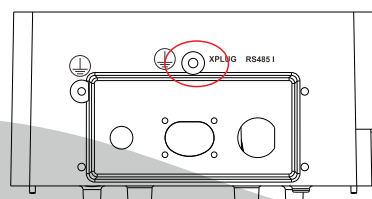

Left side of battery module

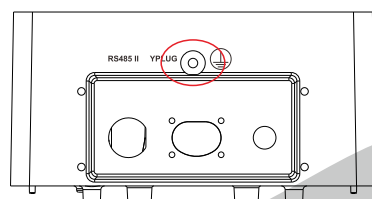

Right side of battery module

XI

Commissioning

If all the battery packs are installed, please follow the following steps:

1. Remove the side cover board of BMS;
2. Rotate the DIP to corresponding number with a small screwdriver according to the number of battery module(s) that has(have) been installed;
3. Switch the breaker to ON;
4. Press the POWER button to turn on the T-BAT system;
5. Reinstall the side cover to BMS;
6. Power on the Inverter.

DIP Configuration:

- 0- Matching one battery module (default)
- 1- Matching two battery modules
- 2- Matching three battery modules
- 3- Matching four battery modules

